

DETACHABLE FRONT PANEL KIT (7 m)

DFK-7

INSTRUCTION MANUAL

KENWOOD

KENWOOD CORPORATION

© PRINTED IN JAPAN B62-0326-00(J, M)(MC)
93/12 11 10 9 8 7 6 5 4 3 2 1 92/12 11 10

■ INSTALLATION

Refer to the instruction manual provided with the transceiver.

■ PARTS

- ① Connectorized Front Panel cable (7 m)
..... E30-3154-05 .. 1 ea.
 - ② Connectorized microphone cable (7 m)
..... E30-3153-05 .. 1 ea.
 - ③ Connectorized speaker cable (5 m)
..... E30-3016-05 .. 1 ea.
 - ④ Connectorized DC power cable (6 m)
..... E30-3032-05 .. 1 ea.
 - ⑤ Mounting bracket J29-0475-04 .. 2 ea.
 - ⑥ Cushion G13-1393-04 .. 2 ea.
- Screw Set N99-0378-05
- ⑦ Front panel screw (3mmx6mm)
..... N82-3006-45 .. 3 ea.
(Use only with TM-732)
 - ⑧ Self-tapping screw (3mm x 25 mm)
..... N46-3025-45 .. 1 ea.
(To attach microphone cable to support)
 - ⑨ Self-tapping screw (3mm x 14 mm)
..... N46-3014-45 .. 4 ea.
(To attach mounting bracket to support)
 - ⑩ Flat washer N15-1030-45 .. 4 ea.
 - ⑪ Machine screw (2.6mmx5mm)
..... N35-2605-45 .. 2 ea.
(* To attach Front Panel to bracket)
 - ⑫ Hex screw N95-4006-45 .. 2 ea.
(To join brackets)
 - ⑬ Allen wrench W01-0401-05 .. 1 ea.
- Instruction Manual B62-0326-XX .. 1 sheet

*Use these screws to attach the Front Panel, consisting of both the Display and Control sections, to the bracket. To attach the Display and Control sections separately to the brackets, use the screws joining the two sections.



■ 設置と接続

設置とケーブルの接続は、トランシーバー本体の取扱説明書をごらんください。

■ 付属品

- ① パネルケーブル (7 m) 1
- ② マイクケーブル (7 m) 1
- ③ スピーカーケーブル (5 m) 1
- ④ DCコード (6 m) 1
- ⑤ 取付アングル 2
- ⑥ クッション 2

ねじセット

- ⑦ タップタイトねじ (TM-732のパネル固定用) 3
 - ⑧ タッピンねじ (3x25 mm) 1
(マイクケーブル固定用)
 - ⑨ タッピンねじ (3x14 mm:アングル固定用) 4
 - ⑩ 平ワッシャー (アングル固定用) 4
 - ⑪ バインド小ねじ (M2.6x5mm:*パネル取付用) 2
 - ⑫ 六角穴付ボルト (アングル組立用) 2
 - ⑬ 六角レンチ 1
- 取扱説明書 1

*表示部と操作部が一体の時のみ使用します。表示部のみ、または操作部のみを使用する場合は、表示部と操作部を固定していたねじを使用して下さい。

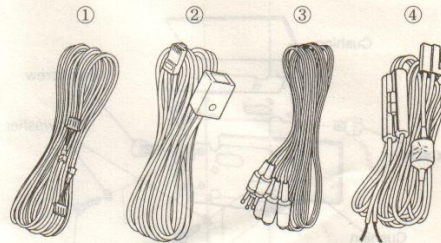

* Use these screws to attach the Front Panel, consisting of both the Display and Control sections, to the bracket. To attach the Display and Control sections separately to the brackets, use the screws joining the two sections.

■ Mounting Bracket Installation

The supplied mounting brackets may be assembled and used in a variety of ways depending on your requirements. Choose the bracket configuration which places the Front Panel in the safest and most convenient position. Also, consider whether the Front Panel will be used as a single unit, or divided into separate Display and Control sections. The accompanying diagram illustrates sideviews of some of the many possible configurations for the brackets.

■ 取付けアングルの組立て例

取付けアングルは2枚の組合せにより、多くのバリエーションで利用することができます。パネルの取付け位置やパネルの分離か一体かの状況などで、より適した組合せをご利用ください。図は六角穴付ボルト取付け面から見たものです。

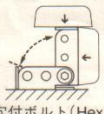
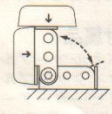
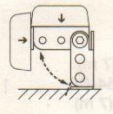
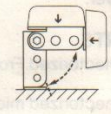
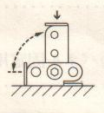
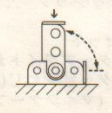
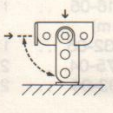
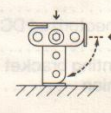
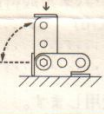
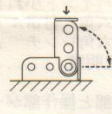
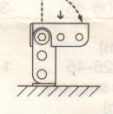
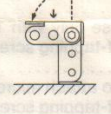
基本の組立 Basic Assembly	位置を変えた時のバリエーション Suggested Mounting Positions		
 <p>◎：六角穴付ボルト (Hex screw) →：パネル部 (Front Panel)</p>			
			
			

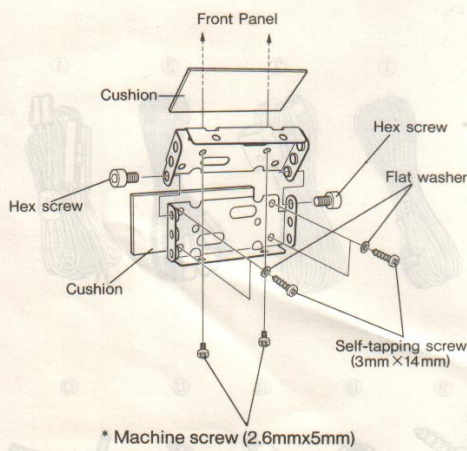

* Use these screws to attach the Front Panel, consisting of both the Display and Control sections, to the bracket. To attach the Display and Control sections separately to the brackets, use the screws joining the two sections.

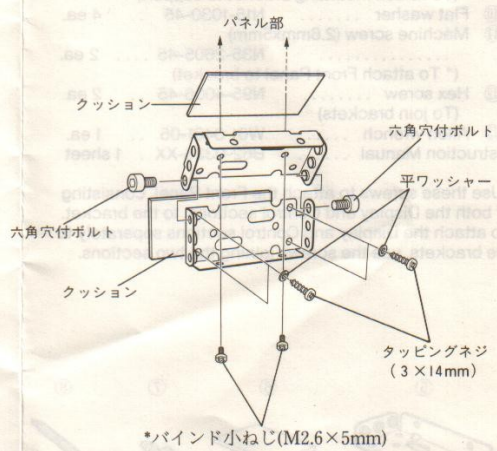

* 表示部と操作部が一体の時のみ使用します。表示部のみ、または操作部のみを使用する場合は、表示部と操作部を固定していたねじを使用して下さい。